

ALS SERIES

Diffuse ringlights

This system provides an ideal frontal diffuse light to obtain great contrast and uniformity. It is placed on camera axis. This application allows the illumination of reflecting objects making textures uniform, eliminating reflections and reducing shadows.

Technical specifications¹

Lighting model	ALSO402A	ALS1105A	ALS1307A	ALS1612A	ALS2315A
Dimensions	48x48x27	Ø126x41	Ø145x41	176x176x13	245x245x13
Inner Ø	21	34	49	120	145
RWD (mm)	>40	>50	>80	70 < x < 320	80 < x < 400
Weight	75g	410g	525g	410g	880g
IP rating	IP40 ²	IP30	IP30	IP40 ²	IP40 ²
Mounting holes	(x2)M4I6 (x3)DIN913 M5@120°	(x2)M4I6 (x3)DIN913 M5@120°	(x3)M4I6 (x3)DIN913 M5@120°	(x3)M4I6 (x3)DIN913 M5@120°	(x7)M4.25xTHRU
Connection (Type C/P/S)	2P male chassis connector PIN 1 = +24V ±3% PIN 2 = 0V	2P male chassis connector PIN 1 = +24V ±3% PIN 2 = 0V	2P male chassis connector PIN 1 = +24V ±3% PIN 2 = 0V	2P male chassis connector PIN 1 = +24V ±3% PIN 2 = 0V	2P male chassis connector PIN 1 = +24V ±3% PIN 2 = 0V
Power cable (Not-included)	VCB Series	VCB Series	VCB Series	VCB Series	VCB Series
Modifiers ³					
Accessories ⁴					
iBlueDrive tech.	inline	Built-in	Built-in	inline	inline
iBlueDrive connection	3P aerial male inline connector. L= 715mm. PIN 1 = +24V ±8% PIN 2 = 0V PIN 3 = Control ⁵	3P male chassis connector PIN 1 = +24V ±8% PIN 2 = 0V PIN 3 = Control ⁵	3P male chassis connector PIN 1 = +24V ±8% PIN 2 = 0V PIN 3 = Control ⁵	3P aerial male inline connector. L= 715mm. PIN 1 = +24V ±8% PIN 2 = 0V PIN 3 = Control ⁵	3P aerial male inline connector. L= 715mm. PIN 1 = +24V ±8% PIN 2 = 0V PIN 3 = Control ⁵
iBlueDrive power cable (Not-included)	VCC Series	VCC Series	VCC Series	VCC Series	VCC Series
iBlueDrive accessories ⁴					

Instantaneous consumption⁶ (max.)

*WT

Lighting model	ALSO402A	ALS1105A	ALS1307A	ALS1612A	ALS2315A		
TYPE C 24VDC		0.8W	7.6W	10W	11W	17W	-470C
		0.8W	7.6W	10W	11W	17W	-525C
		1.3W	7.6W	9.5W	10W	19W	-630C
		1.3W	6.4W	8.2W	10W	21W	-850C
		N/A	N/A	N/A	11W	17W	-W00C
TYPE P D _{max} = 1/2 Ton max = 60s		1.1W	9.5W	13W	N/A	N/A	-400P
		1.1W	8W	11W	N/A	N/A	-W00P
TYPE S D _{max} = 1/20 Ton max = 2ms		175mA / 4.2W	1585mA / 38W	2110mA / 51W	N/A	N/A	-400S
		175mA / 4.2W	1585mA / 38W	2110mA / 51W	2110mA / 51W	3170mA / 76W	-470S
		110mA / 2.6W	990mA / 24W	1320mA / 32W	2110mA / 51W	3170mA / 76W	-525S
		175mA / 4.2W	970mA / 23W	2110mA / 51W	2110mA / 51W	3170mA / 76W	-630S
		420mA / 10W	2300mA / 55W	2925mA / 70W	3760mA / 90W	8800mA / 211W	-850S
		175mA / 4.2W	1585mA / 38W	2110mA / 51W	2110mA / 51W	3170mA / 76W	-W00S
		N/A	1200mA / 29W channel	1500mA / 36W channel	2400mA / 58W channel	3000mA / 72W channel	-RGBS
TYPE i ⁷ 		1.4W[5.3W/1W]	9.1W[44W/4.8W]	12W[48W/6.2W]	N/A	N/A	-400i
		1.3W[5.3W/1.1W]	8.3W[44W/5.7W]	11W[48W/7.4W]	11W[48W/8W]	16W[48W/12W]	-470i
		1.2W[2.9W/0.9W]	7W[22W/3.9W]	9.1W[29W/5.1W]	18W[48W/12W]	16W[48W/12W]	-525i
		1.9W[5.3W/1.4W]	13W[44W/7.4W]	18W[48W/9.1W]	18W[48W/12W]	24W[48W/16W]	-630i
		3.1W[10W/1.9W]	14W[48W/7.1W]	17W[48W/8.9W]	26W[48W/13W]	24W[48W/16W]	-850i
		1.4W[5.3W/1W]	9.1W[44W/4.8W]	12W[48W/6.2W]	18W[48W/12W]	26W[48W/18W]	-W00i

N/A= Not available

Vertrieb durch:

Polytec GmbH
Polytec Platz 1-7
76337 Waldbronn



(1) Environmental specifications and iconography legend in additional annex Z1.4 and Z2 respectively.
(2) IP43 if the system is positioned so that the light falls vertically.
(3) Prior to manufacturing optional modifications in standard lighting systems. Please, consult the code before ordering (additional annex Z2.1).

(4) Accessories are not-included. More information in accessories section.
(5) iBlueDrive control input wiring specifications in additional annex Z1.2.
(6) Bear in mind that consumption table is only to be used as a guide. To refer to real values, please, consult product label when purchasing.
(7) Values of maximum instantaneous consumption of 'Type i' lighting systems in Powered mode (Strobe mode / Continuous mode)



ALS SERIES

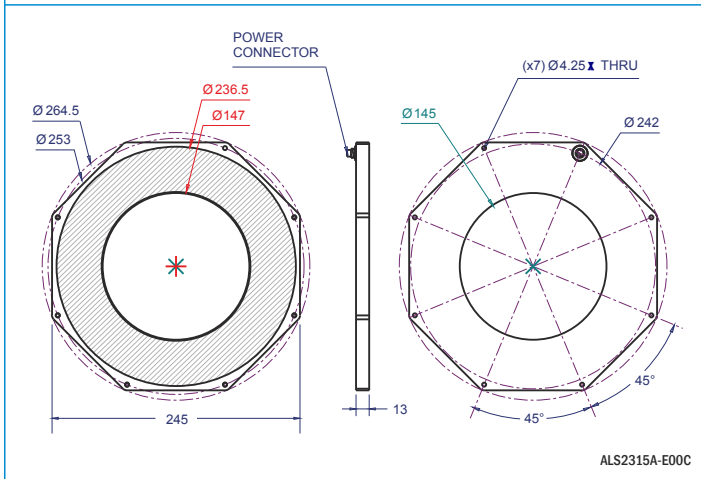
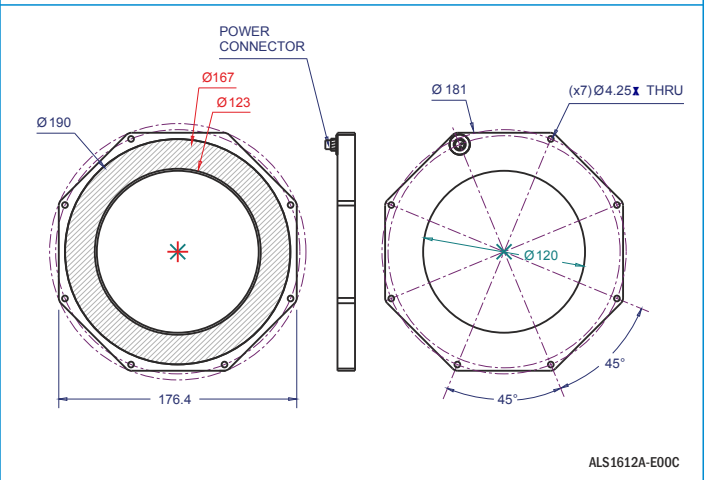
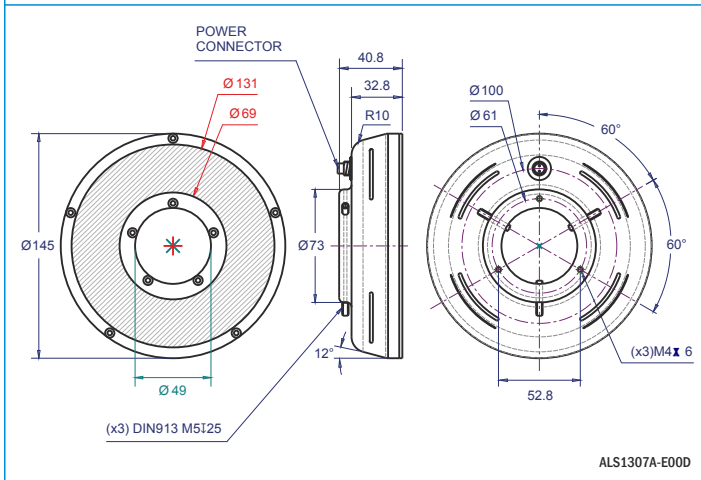
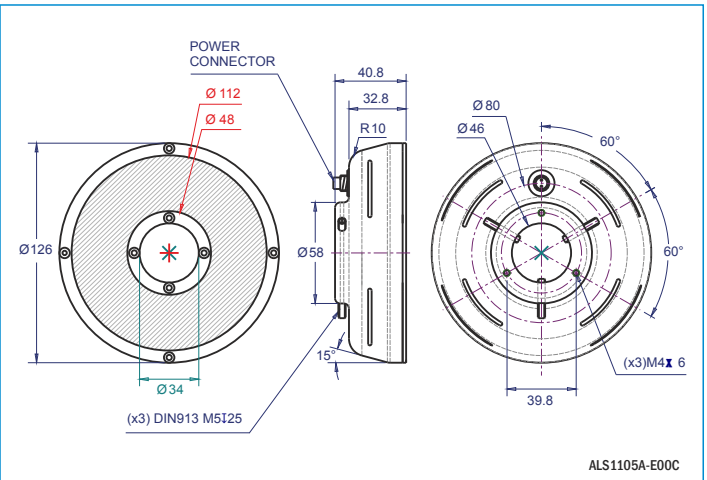
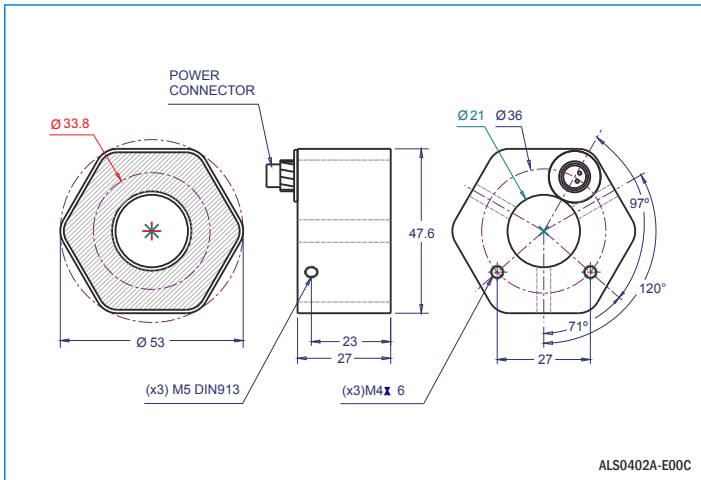

All units in millimeters, if not indicated.

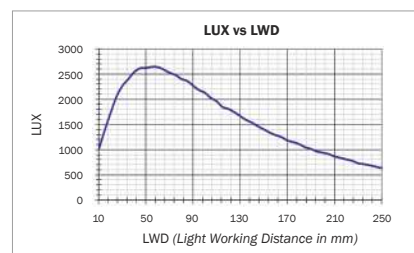
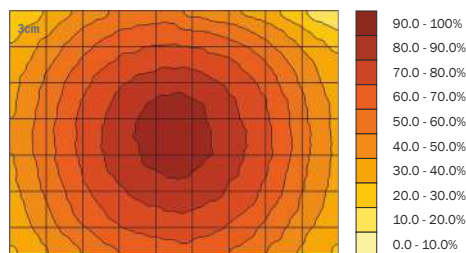



► Z2.1 - iBlueDrive control input wiring

All iBlueDrive products come together with a quick-start guide for connection and working conditions. Refer to iBlueDrive Manual for extended information.

NPN wiring for strobe or ON/OFF mode

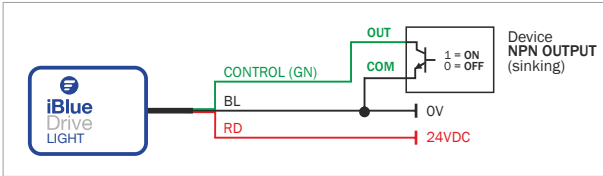

PNP wiring for strobe or ON/OFF mode

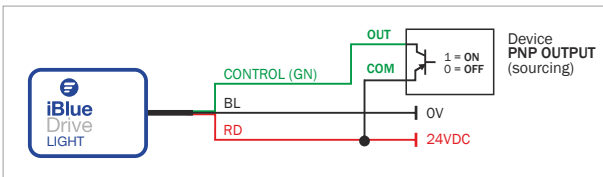

TTL wiring for strobe or ON/OFF mode

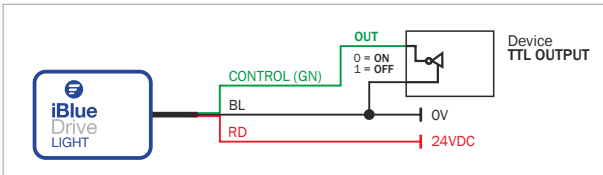

Wiring for continuous mode

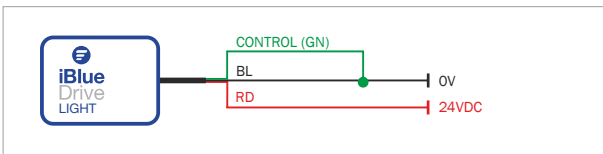

► Z2.2 - iBlueDrive inline

iBlueDrive inline is the driver for iBlueDrive technology integrated as a box of 65x33mm to the cable that goes from the lighting system to the connector. It is used when iBlueDrive driver can not be integrated on chassis. See *diagram*:

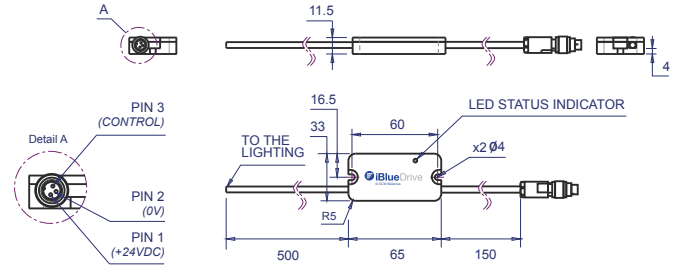



WARNING! In continuous and powered mode, clamp driver to a metal surface for heat dissipation. In Strobe mode is not required, but recommended.

► Z2.3 - iBlueDrive Accessories legend

















icon	Description	Serie/Product
	Accessorie to configure iBlueDrive devices: iBlueDrive Box, iBlueDrive USB	VTA0005A, VTA0006A, VTA0007A
	iBlueDrive optocoupler	VTA0020A
	iBlueDrive potentiometer	VTA0030B















► Z3.1 - Environmental Specifications

Max. Operating Humidity	85% non-condensing
Operating Temperature	0 - 40°C
Storage Temperature	0 - 60°C
Housing material	Anodized aluminium
Standards	  





► Z3.2 - Modifiers legend

icon	Description	Code
	Narrow angle of emission	/AN
	Medium angle of emission (default)	/AM
	Wide angle of emission	/AW
	Oval angle of emission = 23-24° (x) 17-18° (y)	/AO
	Diffuse emission	/AD
	Polarizer filter	/FPL
	Diffuser filter	/FDR
	Backlight hole of 42mm	/H
	Backlight hole of 65mm	/H1
	Dome hole of 46mm	/CC1
	Dome hole of 40mm	/CC2
	IP Rating = IPxx = Ip65 / IP67	/65 / 67
	PNP input model	/P
	50mm focal Length	/F1
	150mm focal Length	/F2
	Infinite focal Length	/F3
	Lighting by sectors = 2 or 4 sectors	/2S / 4S





► Z3.3 - Accessories legend

icon	Description	Serie
	Power cable/s	VCB, VCC, VCD Series
	Other cable/s	VCU, VCL
	Strobe and RGB controller/s	VST, VSC Series
	Polarizer filter	VPF, VPC
	Diffuser filter	VDF
	Collimater filter on x axis	VCFx
	Collimater filter on y axis	VCFy
	Collimater filter on xy axis	VCFxy
	Darkfield converter	VRF
	Protector filter	VPT
	Heat dissipator	VHD
	Fixing bracket	VBA, VBB, VBC Series







► Z3.4 - Technical drawings legend

icon	Description
	Optical axis
	Viewing window dimensions
	Lighting elements
	Light emission center
	Lighting surface dimensions



► Z3.5 - Colours & Wavelegths legend

icon	Wavelength	Colour	Code
	365nm	UV-	-365
	400nm	UV	-400
	470nm	BLUE	-470
	525nm	GREEN	-525
	630nm	RED	-630
	850nm/880nm	IR	-850/-880
		WHITE	-W00
		RGB	-RGB

► Z3.6 - Types of lighting legend

icon	Description
	Radial lighting
	'Darkfield' lighting effect. Low angle illumination
	Backlight illumination
	'Cloudy day' lighting effect
	'Bright field' lighting effect
	Projector lighting
	Axial lighting

► Z3.7 - Types of light legend

icon	Description
	Direct light
	Diffuse light
	Ultra-diffuse light

Vertrieb durch:

Polytec GmbH
Polytec Platz 1-7
76337 Waldbronn

+49 (0) 7243 604-1800
bv@polytec.de
www.polytec.com/bv

