



# Lighting head brackets

Alternative brackets with different dimensions are available to fit the LATAB lighting heads to special requirements. Step files are available on request.

## Mechanical dimensions

Universal, angle for S-series (SXX3 010213)

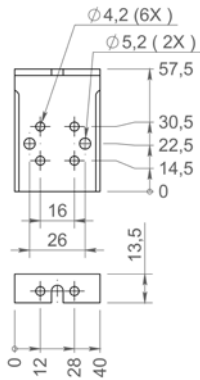

Universal, straight for S-series dark field (LAD3 4011)

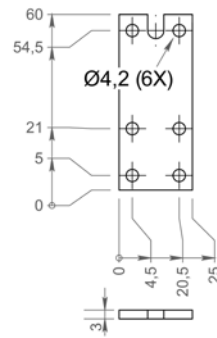

Universal, straight (LAD3 6114)

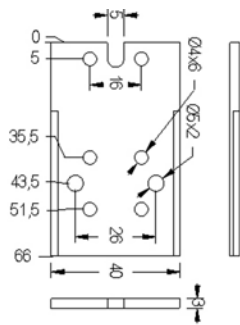

Universal, angle (LAD3 7217)

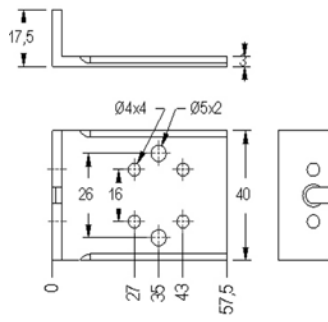

Round for Montech (LDF6 1011)

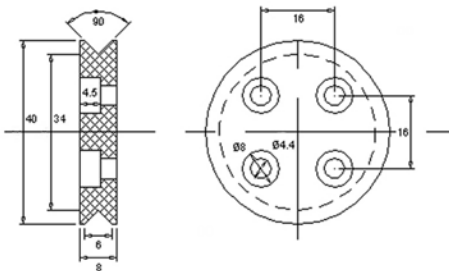

Adjustable, straight (LDF6 1023)

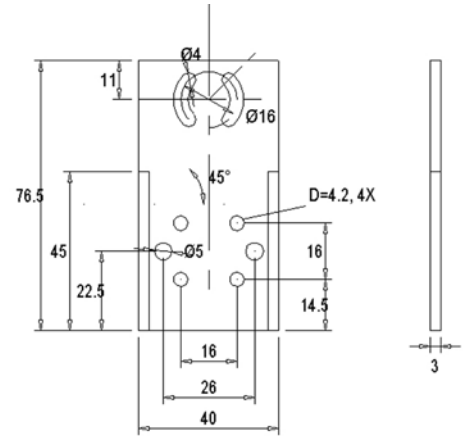

Adjustable, angle (LDF6 1022)

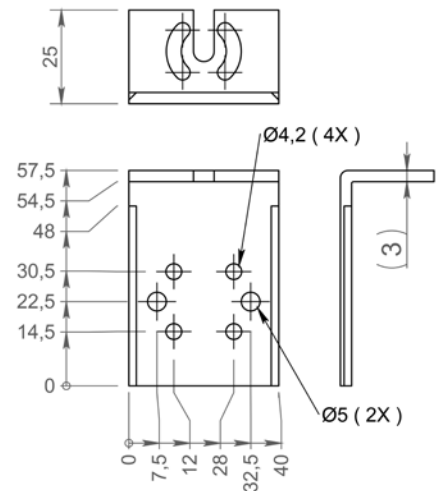

## Order information

Order number	Design
SXX3 010213	Universal, angle for S-series only
LAD3 4011	Universal, straight for dark field of S-series only
LAD2 6114	Universal, straight, for P-series and SXX4, SXX7, SXX9-series
LAD3 7217	Universal, angle, for P-series and SXX4, SXX7, SXX9-series
LDF6 1011	Round for Montech, for P-series and SXX4, SXX7, SXX9-series
LDF6 1023	Adjustable, straight, for P-series and SXX4, SXX7, SXX9-series
LDF6 1022	Adjustable, angle, for P-series and SXX4, SXX7, SXX9-series

Other types and custom designs on request.