

VibroFlex Fiber

The Polytec VibroFlex laser Doppler vibrometer is a modular high-performance solution for non-contact vibration measurement. It offers unrivalled measurement performance and versatility for solving pressing vibration issues in both R&D and industrial quality control.

The VibroFlex family includes the front-end VibroFlex Connect and a selection of non-contact laser sensor heads. Integrated with the VibSoft data acquisition and analysis software, the vibration measurement system is ready to go. Study acoustics, dynamics and vibrations on nano to macro structures without contact and with laser precision.

The VibroFlex Fiber is a fiber-optic vibrometer sensor head and particularly suitable for short measurement distances. Even almost inaccessible measurement points can be reached by using the flexible and slim optical fiber cables. In addition the VibroFlex Fiber sensor head is capable of measuring differentially, i.e. it can acquire relative movements between two sample points. The differential interferometer separates the different motion vectors already in the optical signal path and allows high-resolution measurement with inherent absolute phase stability. Thus VibroFlex Fiber extracts minute vibrations of components on heavily vibrating structures.

VibroFlex – the new flexibility of laser vibration measurement.



Highlights

- 10 mm diameter fiber-optic head reaches hard-to-access areas
- Differential optics measures relative motions between two locations with absolute phase stability
- Micron-sized measurement spot for tiny structures
- Also configurable for single-point vibration measurement
- Wide range of optical accessories available

VibroFlex Fiber

Big insights from small spaces

Datasheet



Technical data



General specifications

Model	VibroFlex Fiber VFX-I-140
Weight	5 kg
Protection class	IP 40
Dimensions (Laser Unit) [L x W x H]	319 x 155 x 163 (114 ¹) mm (12.6 x 6.1 x 6.4 (4.49 ¹) in)
Operating temperature	+5 ... +40 °C (41 ... 104 °F) max. +80 °C (176 °F) for mini fiber head and fiber-optic connection cable
Storage temperature	-10 ... +65 °C (14 ... 149 °F)
Relative humidity	max. 80%, non-condensing
Power consumption	approx. 15 W
Controller compatibility	VibroFlex Connect
Maximum velocity	±12 m/s

Optical specifications

Laser type	Helium Neon (HeNe)
Laser class	Class 2, < 1 mW
Laser wavelength	633 nm, visible red laser beam
Focus	Manual focus
Visibility maxima ²	for differential measurement: $\pm n \cdot 204$ mm; n = 0, 1, 2, 3 ... between stand-off distance of both arms for single-point measurement with VFX-O-130 Reference head: 56 mm + n · 204 mm; n = 0, 1, 2, 3 ...
Total fiber lengths	2 m (optional: 3 m) for each fiber head

Working distance and laser spot size

Fiber head		VFX-O-100 Mini Fiber Head		VFX-O-120 ³ Fiber Head		VFX-O-110 ³ Micro Spot Fiber Head	
Stand-off distance	[mm]	>60 ⁴		>80 ⁴		55 ±2	
Exit beam diameter (1/e ²)	[mm]	2.6 .. 3.5		3.3 .. 3.6		11.4	
Stand-off distance ²		Typical spot size [µm]	Depth-of-field [mm]	Typical spot size [µm]	Depth-of-field [mm]	Typical spot size [µm]	Depth-of-field [mm]
55 mm		–	–	–	–	4.0	±0.02
60 mm		14	±0.24	–	–	–	–
80 mm		20	±0.50	30	±0.40	–	–
100 mm		26	±0.85	27	±0.65	–	–
300 mm		88	±9.7	72	±6.5	–	–
500 mm		152	±29	122	±19	–	–
1,000 mm		314	±122	250	±77	–	–
2,000 mm		650	±524	514	±328	–	–
each additional meter plus		350	–	264	–	–	–





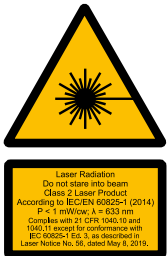

Compliance with standards



Laser safety	IEC/EN 60825-1
Electrical safety	IEC/EN 61010-1
EMC	IEC/EN 61326-1 Emission: Limit class B IEC/EN 61000-3-2 and 61000-3-3 Immunity: IEC/EN 61000-4-2 to 61000-4-6 and IEC/EN 61000-4-11
RoHS	IEC/EN 63000



- ¹ Height of housing without handle
- ² Measured from the shoulder of the fiber heads. Tolerance of ± 15 mm for position of visibility maximum.
- ³ Option
- ⁴ The maximum stand-off distance depends on the backscattering properties of the sample.

Options and accessories

Optical accessories		
VFX-O-100 Mini Fiber Head	Small fiber head (10 mm diameter) with variable working distance (>60 mm) and a laser spot size down to 20 μm (included with sensor head)	
VFX-O-110 Micro Spot Fiber Head	Small fiber head (24 mm max. diameter) with a fixed working distance (55 \pm 2 mm) and a laser spot size of 4 μm	
VFX-O-120 Fiber Head	Small fiber head (24 mm max. diameter) with variable focus (stand-off distance >80 mm) and a laser spot size down to 27 μm	
VFX-O-140 90° Deflection Unit (for VFX-O-100)	90° Deflection Unit for use with VFX-O-100 Mini Fiber Head with a long, thin tip (length 70 mm, diameter 5 mm) for even reaching difficult to access locations	
VFX-O-130 Reference head	Reference head allows making single-point measurements by terminating the reference fiber. The Position of the visibility maxima is fixed at 56 mm + n · 204 mm; n = 0, 1, 2, 3 ...	
VFX-O-131 Reference head	Adjustable reference head allowing to flexibly adapt the optimal working distance (position of visibility maximum) for single-point measurements. For use with VFX-O-120 Fiber Head	

Positioning stages		
VIB-A-P35 4-Axes Precision Stage: XZ plus Tip-Tilt	XY-traverse stage featuring 18 mm travel with $\pm 5^\circ$ pan/tilt function in both directions for positioning a single 10 mm outer diameter Mini Fiber Head.	
VIB-A-P36 Tip-Tilt Precision Stage	For positioning a single 10 mm outer diameter Mini Fiber Head. Travel range $\pm 5^\circ$ in both directions.	
VIB-A-CAS10 Transp. Case (VibroFlex Fiber VFX-I-140)	Robust transportation case for the sensor head and VFX-O-130 Reference head	
VIB-A-CAS15 Transp. Case (VibroFlex Fiber Accessories)	Robust transportation case providing space for VFX-O-131 Reference head, 2 VFX-O-110 Micro Spot Fiber Heads, 2 VFX-O-120 Fiber Heads and 2 VFX-O-140 90° Deflection Units	

Polytec offers a wide range of accessories for setting up and performing measurements. Please contact your local vibrometer sales engineer or visit our website www.polytec.com/vibroflex for more detailed information.

Dimensions

Sensor Head VFX-I-140 VibroFlex Fiber

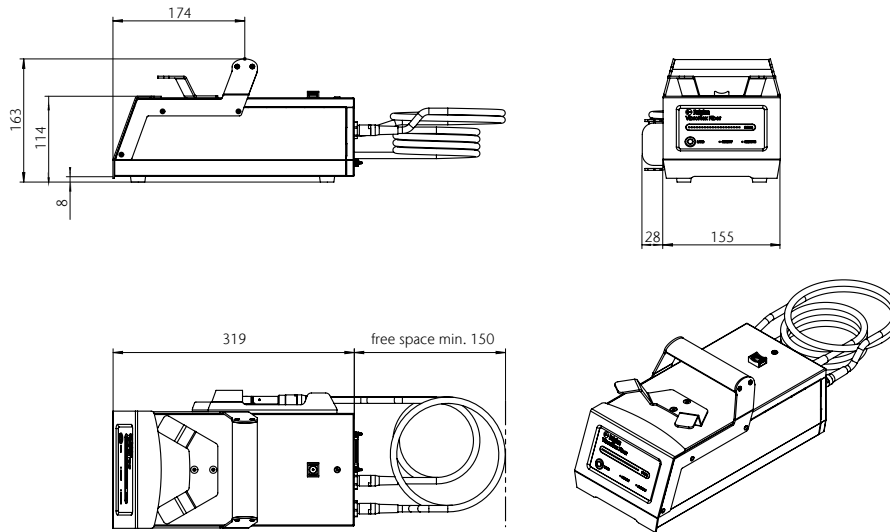

VFX-O-100 Mini Fiber Head

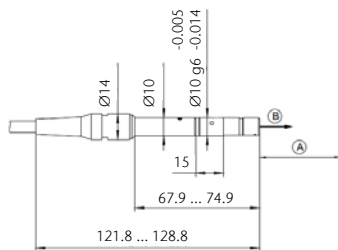

VFX-O-120 Fiber Head

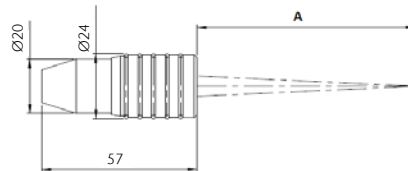

VFX-O-110 Micro Spot Fiber Head

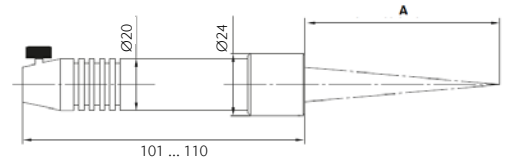

All dimensions in mm if not marked otherwise

(A) Stand-off distance (B) Beam

Shaping the future since 1967

High tech for research and industry.
Pioneers. Innovators. Perfectionists.

Find your Polytec representative:
www.polytec.com/contact

Polytec GmbH · Germany
Polytec-Platz 1-7 · 76337 Waldbronn